

ACCESS COVER
30 1/4" O.D X 12 1/2" H X 6mm T
SS304

ALIBATA INSCRIPTION
5mm W/ WITH WHITE ACRYLIC
COVER & BACK LIGHT

BAMBOO SCULPTURE
30" O.D X 120" H X 6mm T
SS304

HOLE FOR DRAIN

48" x 48" x 19mm T SS304
BASE STEEL PLATE

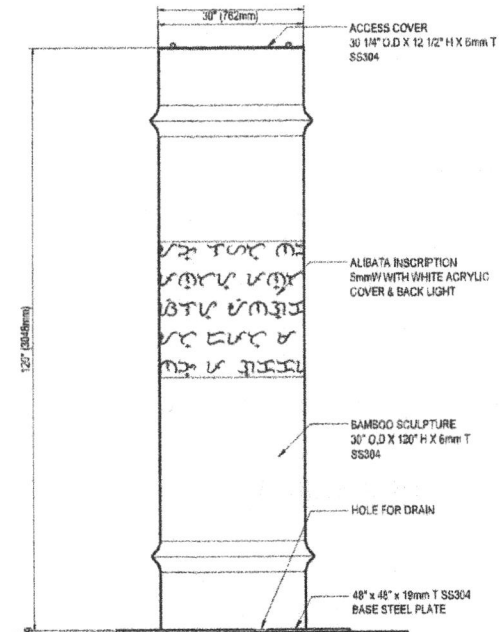

ACCESS COVER
30 1/4" O.D X 12 1/2" H X 6mm T
SS304

ALIBATA INSCRIPTION
5mm W/ WITH WHITE ACRYLIC
COVER & BACK LIGHT

BAMBOO SCULPTURE
30" O.D X 120" H X 6mm T
SS304

HOLE FOR DRAIN

48" x 48" x 19mm T SS304
BASE STEEL PLATE

EXTRA DUTY WHILE-IN-USE WEATHERPROOF
UTILITY BOX WITH HEAVY DUTY COVER
(FLUSH WALL MOUNT)

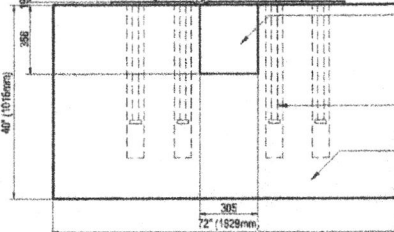

SPACE FOR PLAQUE

EXTRA DUTY WHILE-IN-USE WEATHERPROOF
UTILITY BOX WITH HEAVY DUTY COVER
(FLUSH WALL MOUNT)

6 pcs. - 1/2" Ø X 700mm L
STAINLESS STEEL STUDS

CONCRETE PEDESTAL
CERAMIC TILE OF ONE COLOUR
OR WASHED OUT PEBBLES ON
ONE COLOUR CAN USED.

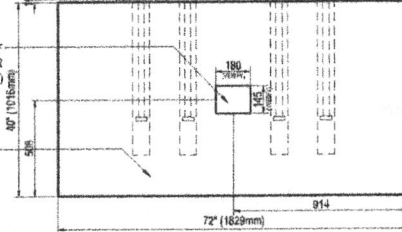

SPACE FOR PLAQUE

EXTRA DUTY WHILE-IN-USE WEATHERPROOF
UTILITY BOX WITH HEAVY DUTY COVER
(FLUSH WALL MOUNT)

6 pcs. - 1/2" Ø X 700mm L
STAINLESS STEEL STUDS

CONCRETE PEDESTAL
CERAMIC TILE OF ONE COLOUR
OR WASHED OUT PEBBLES ON
ONE COLOUR CAN USED.

FRONT ELEVATION

SCALE 1:100m

REAR ELEVATION

SCALE 1:100m

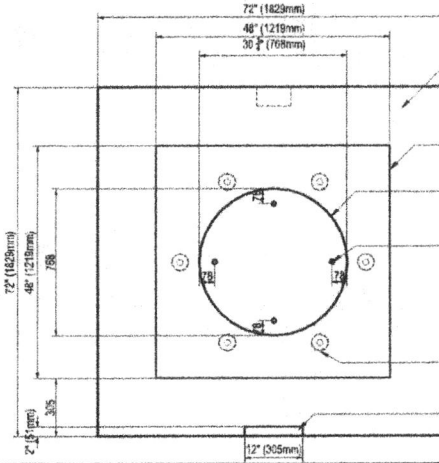

CONCRETE PEDESTAL
CERAMIC TILE OF ONE COLOUR
OR WASHED OUT PEBBLES ON
ONE COLOUR CAN USED.

48" x 48" x 19mm T SS304
BASE STEEL PLATE

BAMBOO SCULPTURE
30" O.D X 120" H X 6mm T
SS304

4 SETS - SECURING BOLTS

6 pcs. - 3/4" Ø X 900mm L
S/S SLEEVE PIPE EMBEDDED
ON CONCRETE PEDESTAL

SPACE FOR PLAQUE

PLAN

SCALE 1:100m

- NOTES:**
- 1) FOR THE FINISH OF THE CONCRETE PEDESTAL, CERAMIC TILE OF ONE COLOUR OR WASHED OUT PEBBLES ON ONE COLOUR CAN USED.
 - 2) THERE SHOULD BE NO OTHER WRITINGS INCLUDED.
 - 3) PLAQUE SPACE IS 12" X 14" OR PROPORTIONATE TO THE SPACE PROVIDED FOR IT.

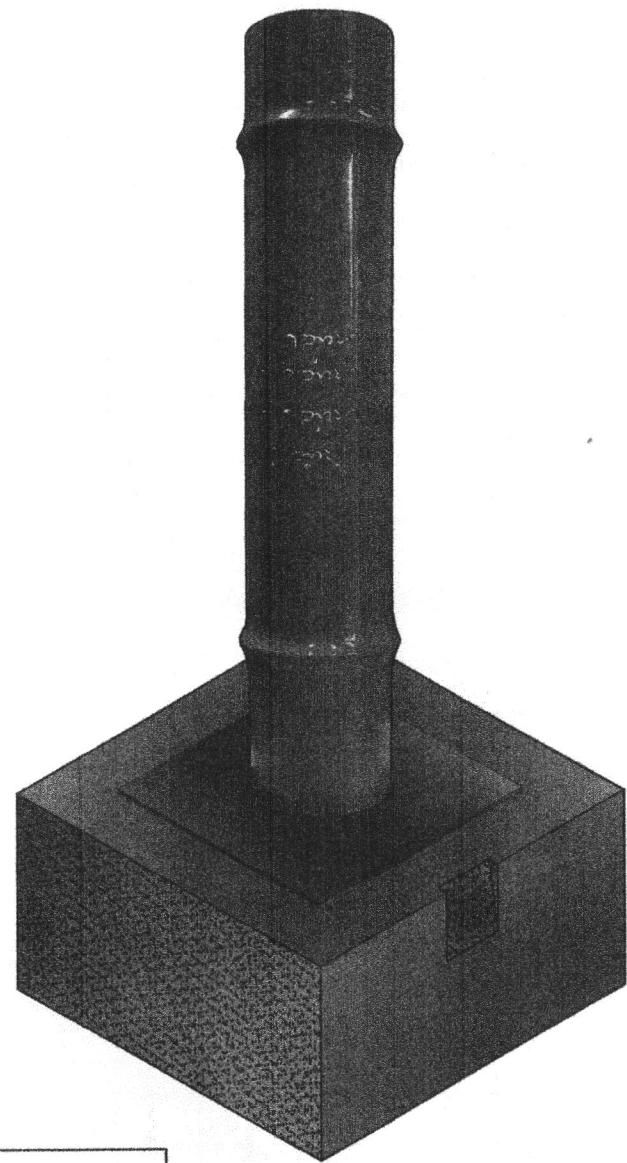

ISOMETRIC

CONTRACTOR
REYNOR ARTS AND INDUSTRIAL SUPPLY
B4A, L1B, Calamba Premiere International Park
Barangay Batino, Calamba City, Laguna
Telefax: (049) 502-2290, Mobile no: 09175075494 / 09985303998

PRC NO.	PTR NO.
TIN	PLACE

PROJECT TITLE
**BANTAYOG NG WIKA
SCULPTURE, BASE & PEDESTAL**

APPROVED BY

LOCATION:

REVISIONS	DATE	SHEET CONTENT

AS SHOWN

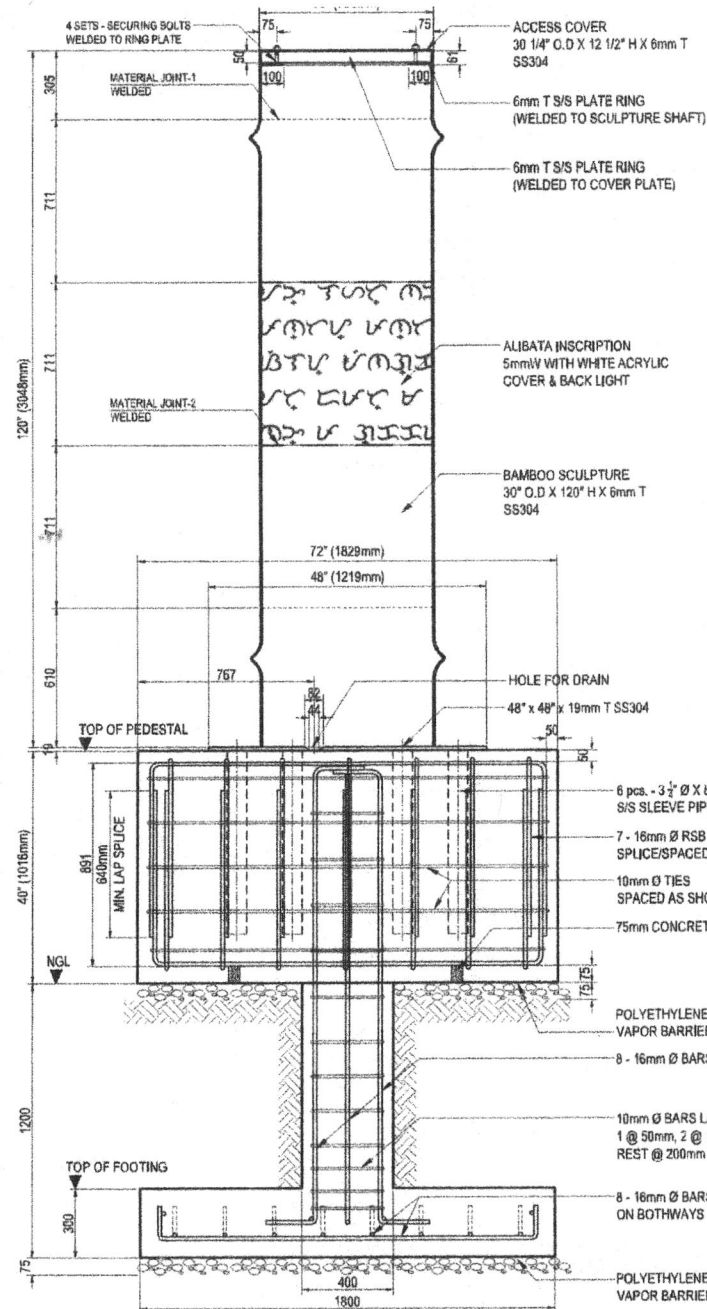

SECTION

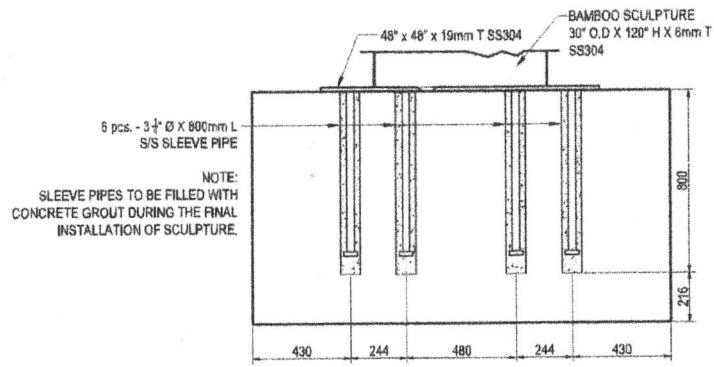

S/S SLEEVE PIPES LAYOUT DETAIL

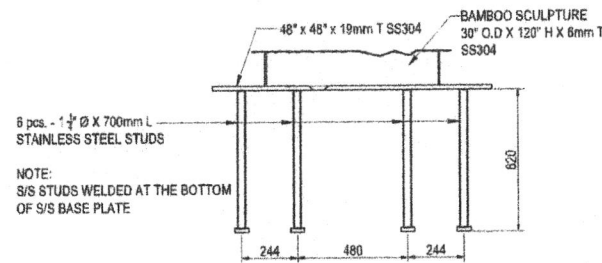

S/S STUDS LAYOUT DETAIL

NOTE:

1. USED CLASS "A" CONCRETE MIXTURE (1:2:4) 3500 PSI
1 - CEMENT, 2 - SAND, 4 - GRAVEL
2. AFTER CASTING OF PEDESTAL, COVER THE CONCRETE WITH BURLAP & KEEP MOISTURE CURING (WITH WATER) FOR 7 DAYS TO ATTAIN ITS 65% COMPRESSIVE STRENGTH. (PROTECT THE CONCRETE FROM EXCESSIVE EXPOSURE FROM HEAT, WIND & DRYING).
3. USE THE CONCRETE PEDESTAL AFTER 14 DAYS. (90% COMPRESSIVE STRENGTH)

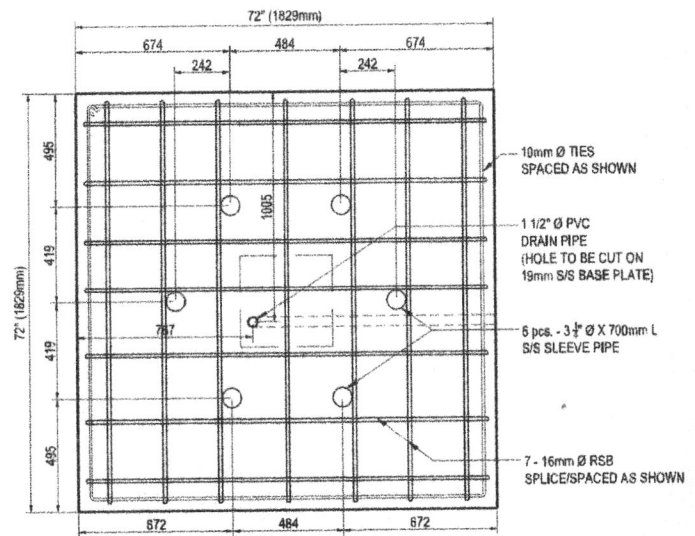

PLAN (PEDESTAL)

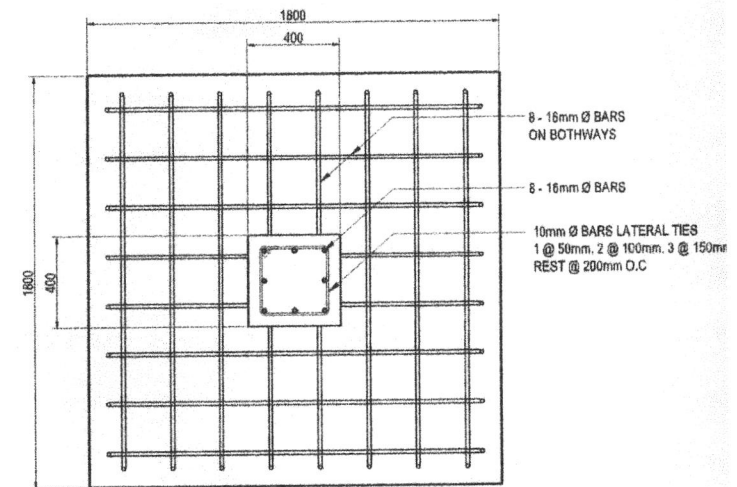

PLAN (FOOTING)

FOUNDATION PLAN

SCALE 1:100m.

CONTRACTOR
REYNOR ARTS AND INDUSTRIAL SUPPLY
 B4A, L1B, Calamba Premiere International Park
 Barangay Batino, Calamba City, Laguna
 Telefax: (049) 502-2290, Mobile no: 09175075494 / 09985303998

PRC NO.	PTR NO.
TIN	DATE
	PLACE

PROJECT TITLE
**BANTAYOG NG WIKA
 SCULPTURE, BASE & PEDESTAL**

LOCATION:

APPROVED BY

REVISIONS	DATE	SHEET CONTENT

SHEET NO.
 AS SHOWN

S
11

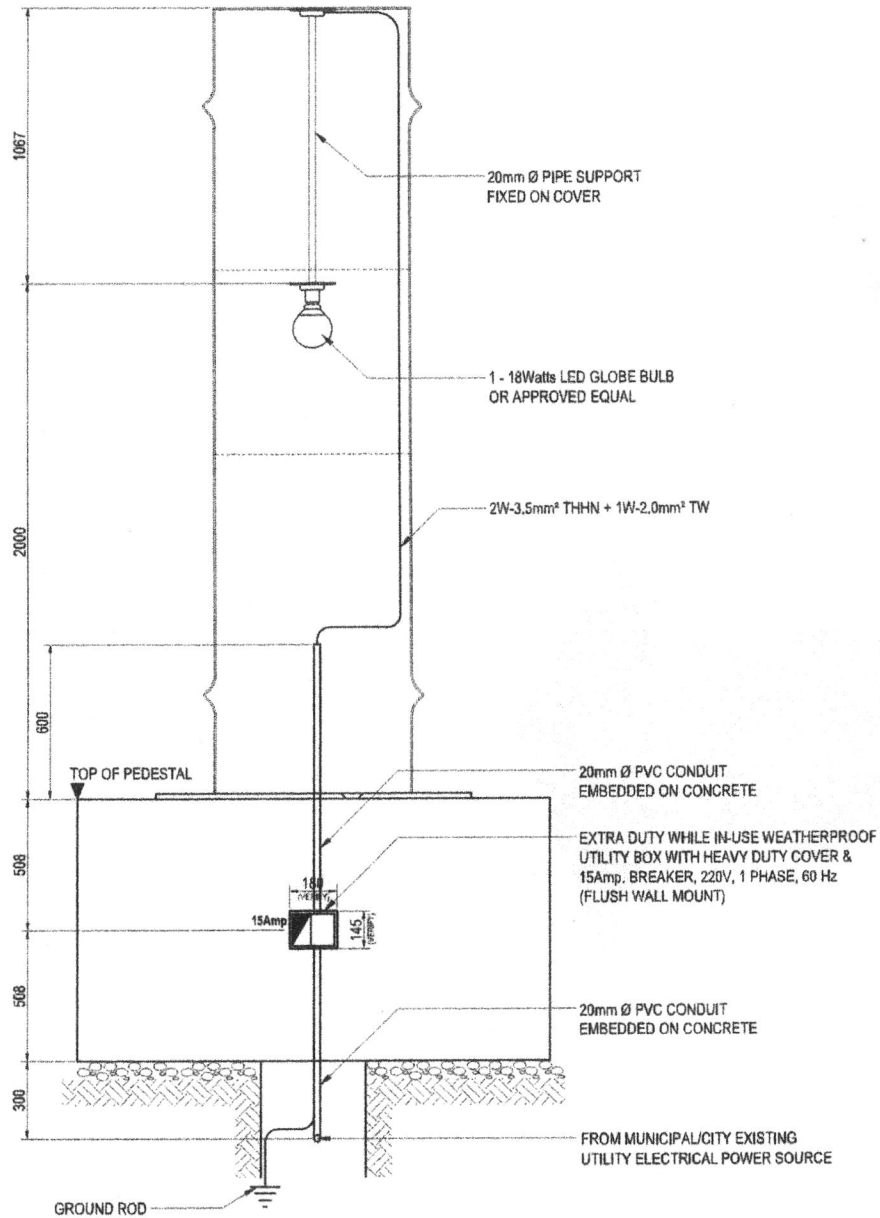

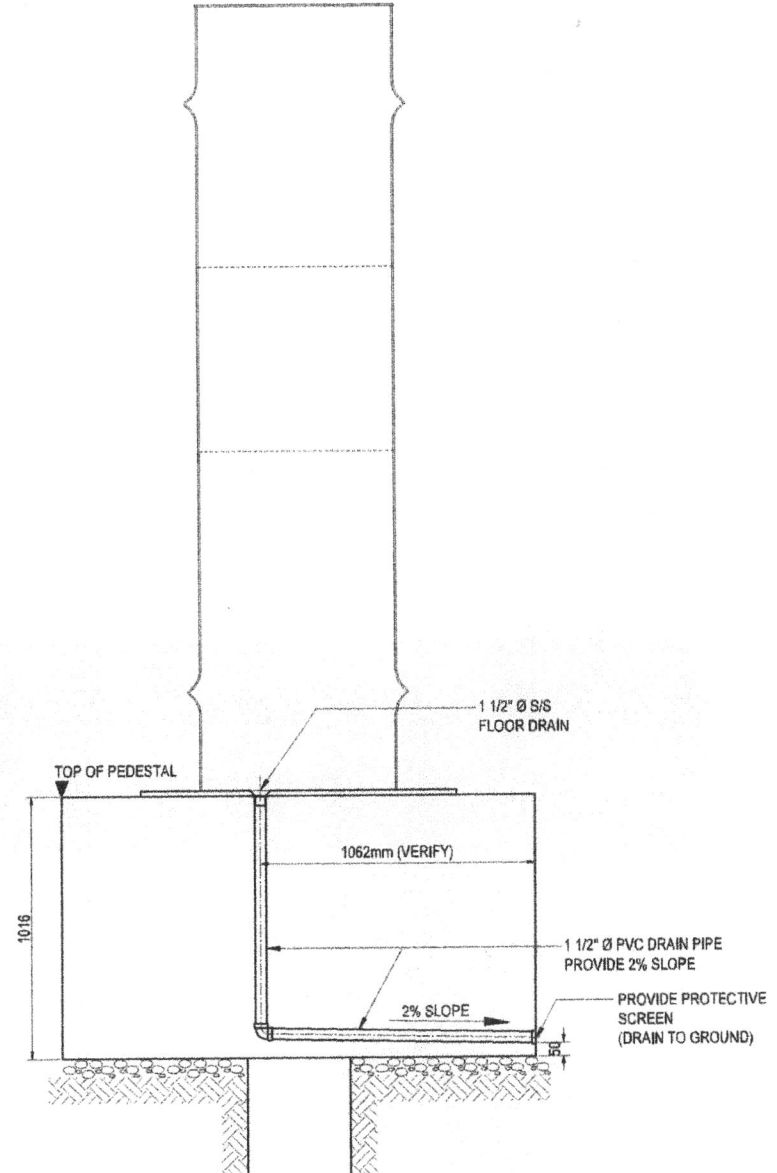

ELECTRICAL PLAN & DETAILS

SCALE 1:100m.



PLUMBING PLAN & DETAILS

SCALE 1:100m.

CONTRACTOR		PROJECT TITLE		APPROVED BY	REVISIONS	DATE	SHEET CONTENT	SHEET NO.
 REYNOR ARTS AND INDUSTRIAL SUPPLY B4A, L1B, Calamba Premiere International Park Barangay Batino, Calamba City, Laguna Telefax: (049) 502-2290, Mobile no: 09175075494 / 09985303998		BANTAYOG NG WIKA SCULPTURE, BASE & PEDESTAL					AS SHOWN	
PRC NO.	PTR NO.	DATE	PLACE	LOCATION:				

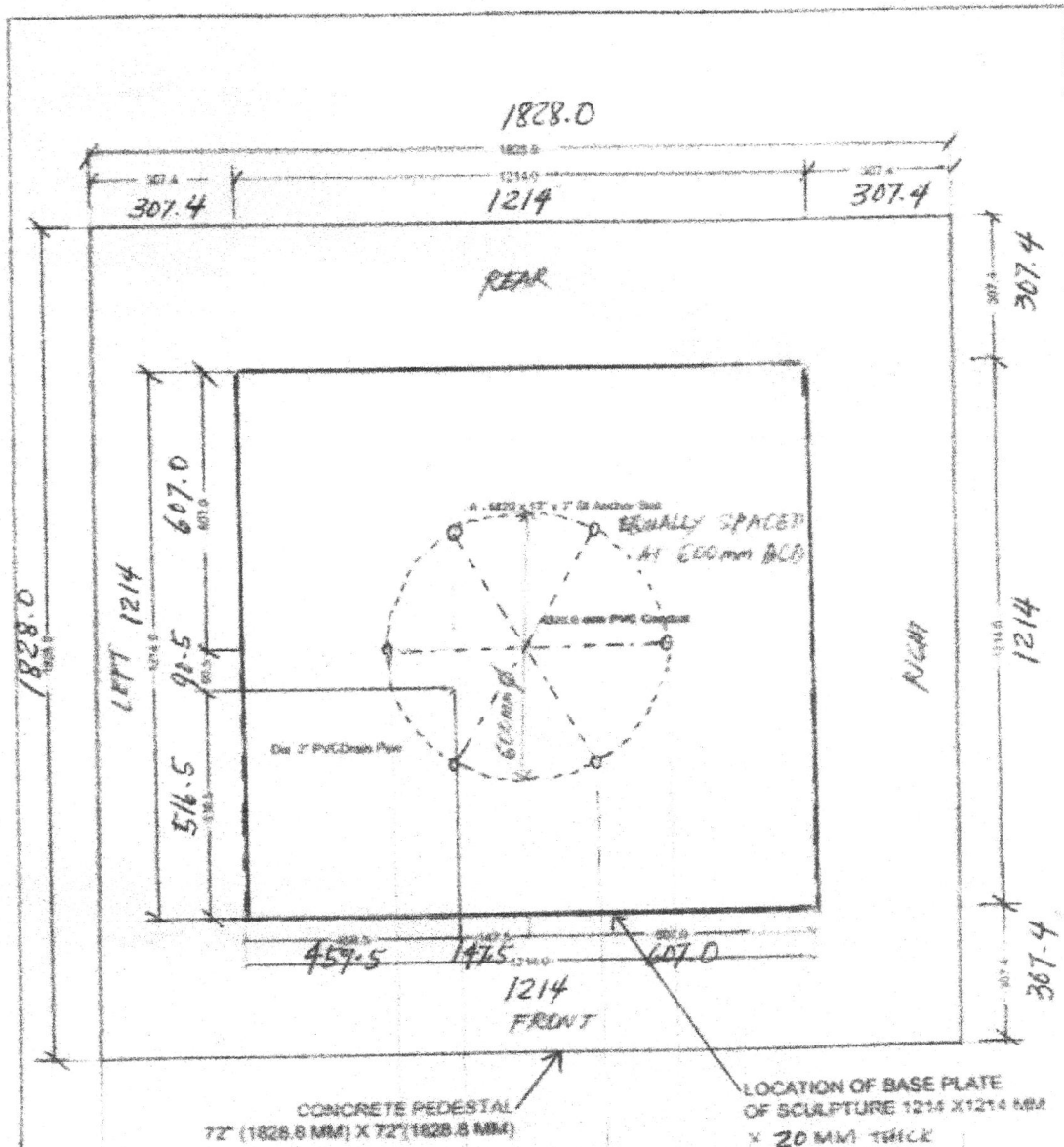

TOP VIEW

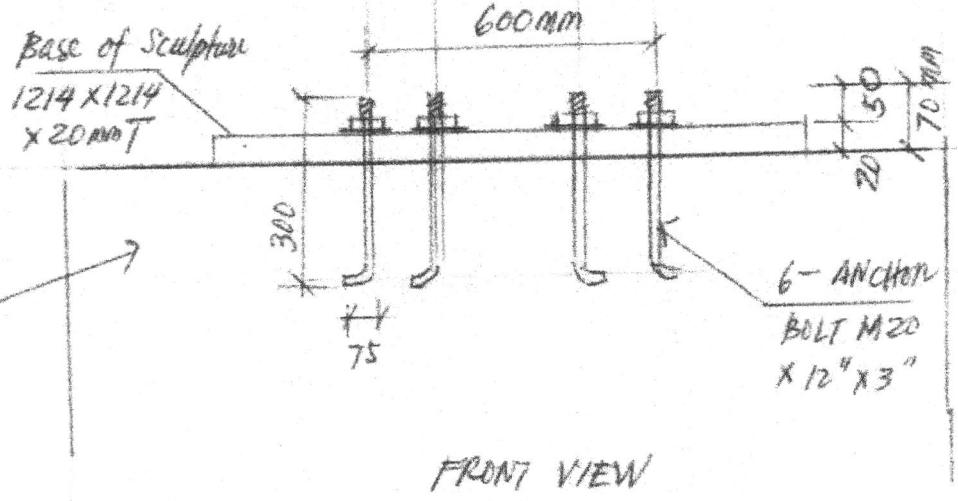

CONCRETE PEDESTAL

<p>Reynor Arts and Industrial Supply</p> <p>Telephone No. (049) 520-5493</p> <p>ADDRESS: 66119 CALAMBA PREMIER INTERNATIONAL PARK BATINO CALAMBA CITY LASUNA</p>		<p>TITLE:</p> <p>Base Plate Location Plan</p>	
APPROVED BY	REP	DESIGNED BY	SP
REVISION NO		DATE	03-29-16

Design: Bamboo-inspired sculpture

Size: 10ft. (height) x 2ft. (diameter)

Material: Fabricated stainless steel (main sculpture)
White acrylic sheet – inside (light diffuser)
Electrical system for inside lighting

Color: powder-coating

Process: Molding or Sheet pressing and binding for
the sculpture; and
Laser or plasma cutting for the design

